

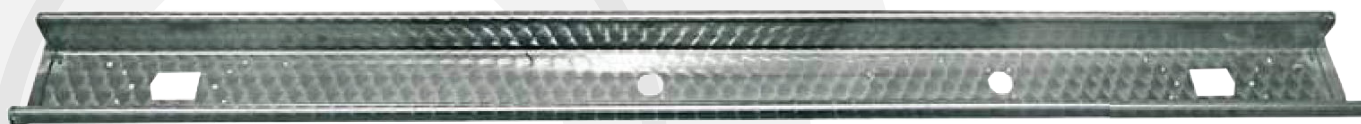

OFFICINE MECCANICHE MAIOLI

Accessori per veicoli industriali

8



- **PORTALAMPEGGIATORI**
- **PASSERELLE**
- **SERIE ATTACCHI**
- **PARAURTI**
- **TAMPONI PER PARAURTI**
- **CALZATOIE OMOLOGATE**
- **SUPPORTI PARACICLISTI**
- **PORTA TARGA**
- **VERRICELLI**
- **BALCONCINO ANTERIORE SEMIRIMORCHIO**
- **GRIGLIA PARASASSI**



OFFICINE MECCANICHE MAIOLI
Accessori per veicoli industriali



PORTALAMPEGGIATORI

Codice	Descrizione	L
MM0801001-1	Portalampeggiatore - Portascritte z. Mercedes - Actros - Scania	1800
MM0801001-2	Portalampeggiatore - Portascritte z. Autocarri pesanti	1800
MM0801001-3	Portalampeggiatore - Portascritte z. Autocarri medi	1600
MM0801001-4	Portalampeggiatore - Portascritte z. Mercedes - Actros - Scania 144	1800
MM0801001-5	Portalampeggiatore Alluminio Autocarri pesanti	1800
MM0801001-6	Portalampeggiatore Alluminio Autocarri medi	1600
MM0801001-7	Portalampeggiatore - Portascritte z. Daily City	1620



OFFICINE MECCANICHE MAIOLI

Accessori per veicoli industriali



PASSERELLE

Codice	Descrizione	L
MM0802001-1	Passerella C/alluminio mandorlato Autocarri pesanti	1800
MM0802001-2	Passerella C/alluminio mandorlato Autocarri medi	1600
MM0802001-3	Passerella C/alluminio mandorlato	1960X330
MM0802001-4	Passerella inox C/alluminio Autocarri pesanti	1800
MM0802001-5	Passerella C/alluminio mandorlato Scania 144 Mercedes Actros	1800
MM0802001-6	Passerella inox C/alluminio mandorlato Scania 144 Mercedes Actros	1600
MM0802001-7	Passerella alluminio autocarri pesanti	1800
MM0802001-8	Passerella alluminio autocarri medi	1600



OFFICINE MECCANICHE MAIOLI

Accessori per veicoli industriali



SERIE ATTACCHI

Codice	Descrizione
MM0803001-1	Serie attacchi curvi Z. Mercedes - Actros c/cabina lunga corta
MM0803001-2	Serie attacchi curvi completa Z. Iveco Daily furgone
MM0803001-3	Serie attacchi curvi completa Z. Scania 94 - 124 c/cabina corta
MM0803001-4	Serie attacchi curvi completa Z. Scania 144
MM0803001-5	Serie attacchi curvi completa Z. Mercedes - Ateco c/cabina corta
MM0803001-6	Serie attacchi curvi completa Z. Mercedes - Ateco c/cabina lunga
MM0803001-7	Serie attacchi curvi completa Z. Daily City cassonato
MM0803001-8	Serie attacchi curvi completa Z. Mercedes 1944 814 1320
MM0803001-9	Serie attacchi curvi completa Z. Mercedes - Actros c/cabina lunga corta
MM0803001-10	Serie attacchi Z. Mercedes 1944



OFFICINE MECCANICHE MAIOLI

Accessori per veicoli industriali



SERIE ATTACCHI

Codice	Descrizione
MM0803002-1	Serie attacchi curvi completa Z. 50 - F90 - 109.14 DAF 1700
MM0803002-2	Serie attacchi curvi completa Z. 100 - 130 - 115.17 - DAF 110 - FL6
MM0803002-3	Serie attacchi curvi completa Z. 170 - 190.38 VOLVO F10
MM0803002-4	Serie attacchi curvi completa Z. 50NC MREC. 809 c/corta
MM0803002-5	Serie attacchi curvi completa Z. Renault 370 - 365
MM0803002-6	Serie attacchi curvi completa Z. Mercedes 19 - Scania 113
MM0803002-7	Serie attacchi curvi completa Z. Iveco 330 - DAF 95
MM0803002-8	Serie attacchi curvi completa Z. Scania 141
MM0803002-9	Serie attacchi curvi completa Z. VOLVO FH16
MM0803002-10	Serie attacchi curvi completa Z. Iveco 190 - 42
MM0803002-11	Serie attacchi curvi completa Z. Eurocargo - Eurotech c/lunga
MM0803002-12	Serie attacchi curvi completa Z. Eurocargo - Eurotech s/botola
MM0803002-13	Serie attacchi curvi completa Z. Eurocargo c/cabina corta
MM0803002-14	Serie attacchi curvi completa Z. Eurocargo - Eurotech a/bassi
MM0803002-15	Serie attacchi curvi completa Z. Eurocargo - Eurotech t/cabina
MM0803002-16	Serie attacchi curvi completa Z. Eurotech c/cabina



OFFICINE MECCANICHE MAIOLI
Accessori per veicoli industriali

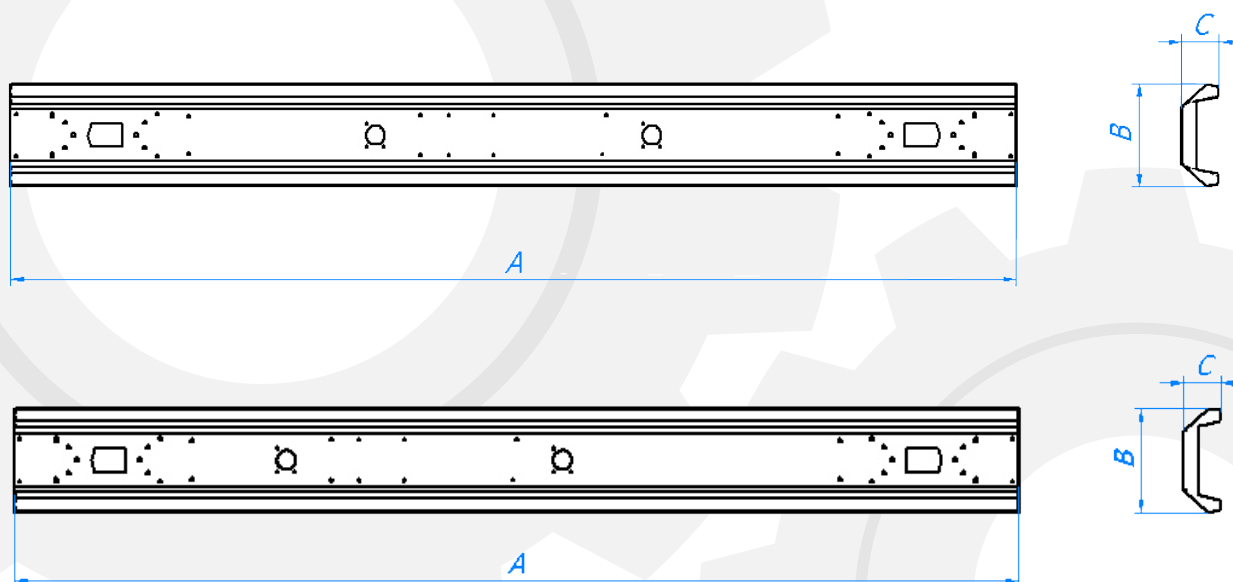

BARRA PORTAFANALI INOX FIORETTATO

Codice	Descrizione	A	B	C
MM0804001-1	Barra portafanali Inox fiorettato targa centrale	2300	245	90
MM0804001-2	Barra portafanali Inox fiorettato targa centrale	2400	245	90
MM0804001-3	Barra portafanali Inox fiorettato targa laterale	2300	245	90
MM0804001-4	Barra portafanali Inox fiorettato targa laterale	2400	245	90



OFFICINE MECCANICHE MAIOLI
Accessori per veicoli industriali

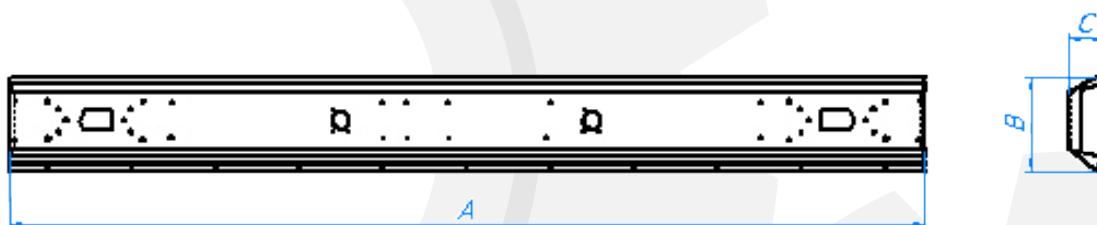

BARRA PORTAFANALI INOX FIORETTATO

Codice	Descrizione	A	B	C
MM0804002-1	Barra portafanali Inox fiorettato targa centrale	2300	245	90
MM0804002-2	Barra portafanali Inox fiorettato targa centrale	2400	245	90
MM0804002-3	Barra portafanali Inox fiorettato targa laterale	2300	245	90
MM0804002-4	Barra portafanali Inox fiorettato targa laterale	2400	245	90



OFFICINE MECCANICHE MAIOLI
Accessori per veicoli industriali

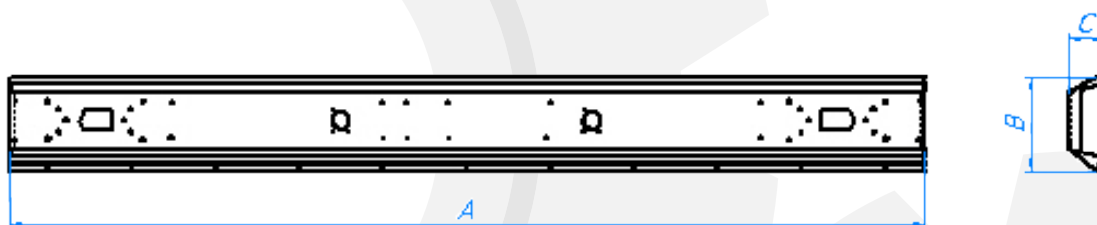

BARRA PORTAFANALI INOX FIORETTATO CON ATTACCO PARASPRUZZO

Codice	Descrizione	A	B	C
MM0804003-1	Barra portafanali Inox fiorettato targa centrale	2300	245	90
MM0804003-2	Barra portafanali Inox fiorettato targa centrale	2400	245	90
MM0804003-3	Barra portafanali Inox fiorettato targa laterale	2300	245	90
MM0804003-4	Barra portafanali Inox fiorettato targa laterale	2400	245	90



OFFICINE MECCANICHE MAIOLI

Accessori per veicoli industriali

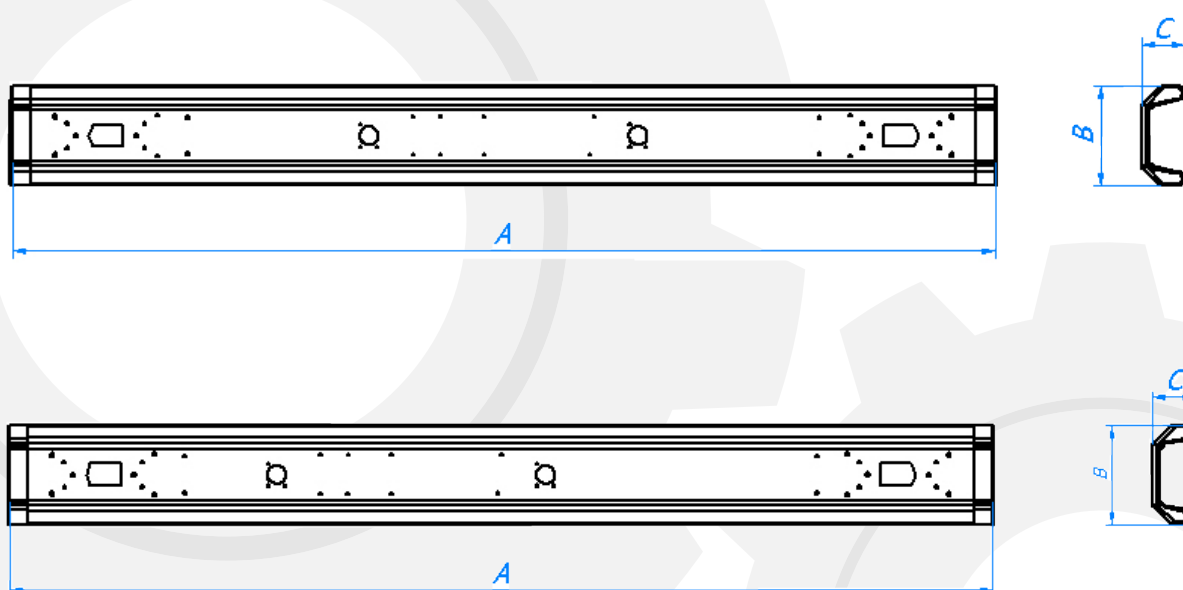

BARRA PORTAFANALI INOX FIORETTATO CON TAMPONE LATERALE

Codice	Descrizione	A	B	C
MM0804004-1	Barra portafanali Inox fiorettato targa centrale	1800	250	105
MM0804004-2	Barra portafanali Inox fiorettato targa centrale	1900	250	105
MM0804004-3	Barra portafanali Inox fiorettato targa centrale	2000	250	105
MM0804004-4	Barra portafanali Inox fiorettato targa centrale	2100	250	105
MM0804004-5	Barra portafanali Inox fiorettato targa centrale	2200	250	105
MM0804004-6	Barra portafanali Inox fiorettato targa centrale	2300	250	105
MM0804004-7	Barra portafanali Inox fiorettato targa centrale	2400	250	105



OFFICINE MECCANICHE MAIOLI
Accessori per veicoli industriali

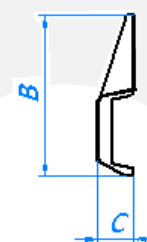
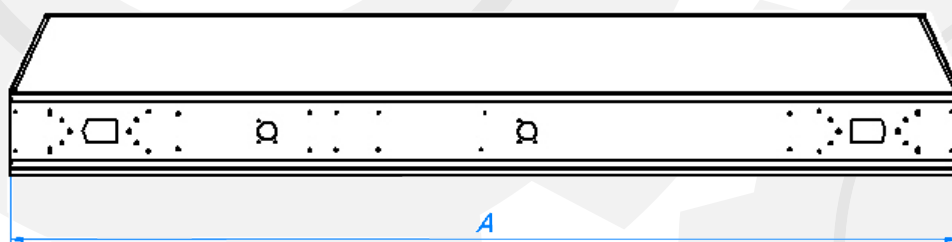
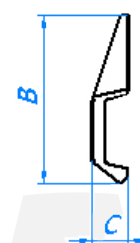
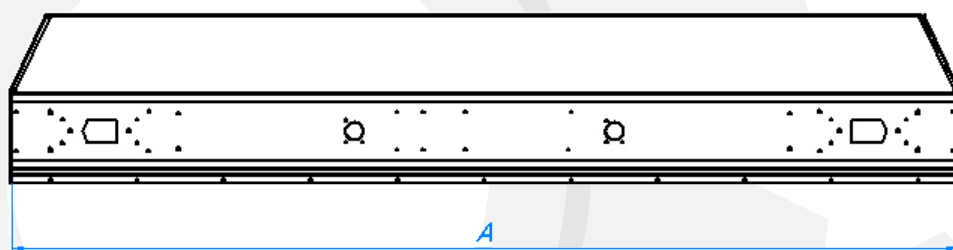
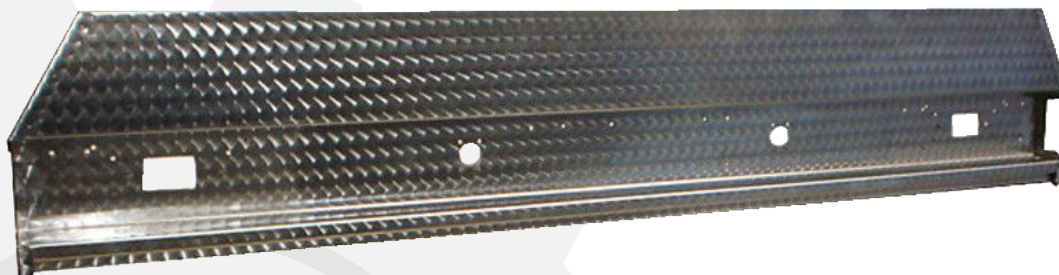

BARRA PORTAFANALI INOX FIORETTATO CON ALZATA E ATTACCO PARASPRUZZI

Codice	Descrizione	A	B	C
MM0804005-1	Barra portafanali Inox fiorettato targa centrale	2300	430	95
MM0804005-2	Barra portafanali Inox fiorettato targa centrale	2400	430	95
MM0804005-3	Barra portafanali Inox fiorettato targa laterale	2300	245	105
MM0804005-4	Barra portafanali Inox fiorettato targa laterale	2400	245	105



OFFICINE MECCANICHE MAIOLI

Accessori per veicoli industriali

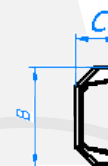
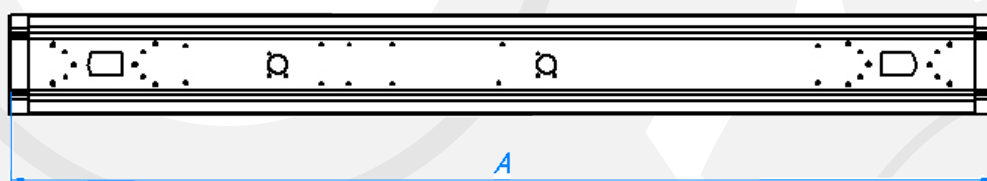
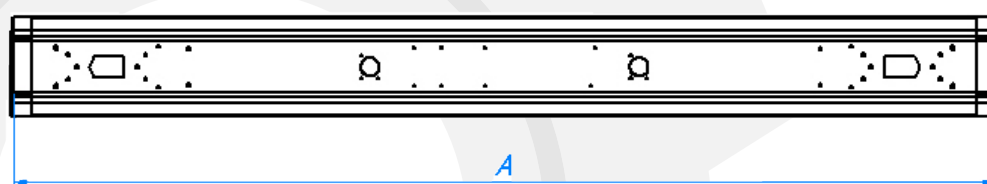

BARRA PORTAFANALI VERNICIATO CON TAMPONE LATERALE

Codice	Descrizione	A	B	C
MM0804006-1	Barra portafanali Inox fiorettato targa centrale	1800	250	105
MM0804006-2	Barra portafanali Inox fiorettato targa centrale	1900	250	105
MM0804006-3	Barra portafanali Inox fiorettato targa centrale	2000	250	105
MM0804006-4	Barra portafanali Inox fiorettato targa centrale	2100	250	105
MM0804006-5	Barra portafanali Inox fiorettato targa centrale	2200	250	105
MM0804006-6	Barra portafanali Inox fiorettato targa centrale	2300	250	105
MM0804006-7	Barra portafanali Inox fiorettato targa centrale	2400	250	105



OFFICINE MECCANICHE MAIOLI

Accessori per veicoli industriali

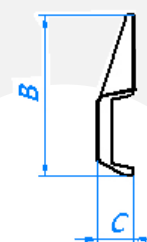
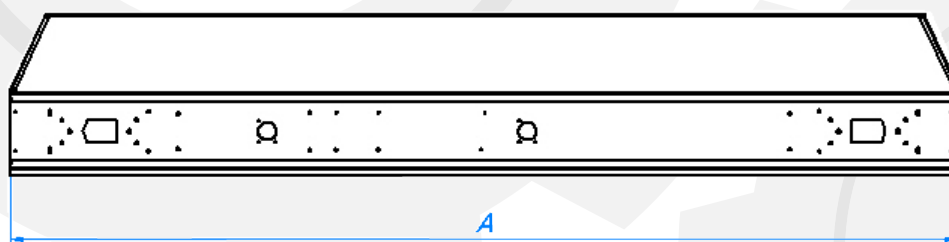
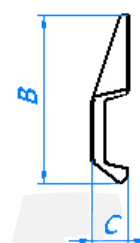
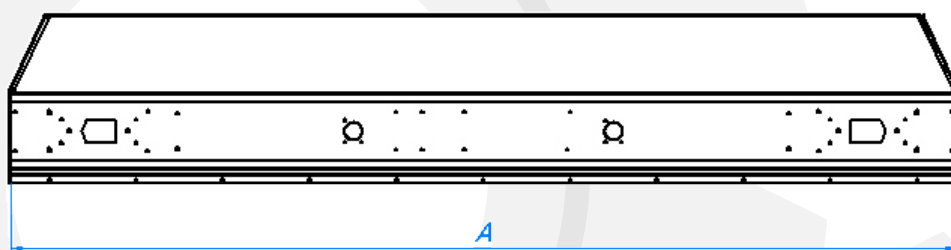

BARRA PORTAFANALI VERNICIATOTO CON ALZATA E ATTACCO PARASPRUZZI

Codice	Descrizione	A	B	C
MM0804007-1	Barra portafanali Inox fiorettato targa centrale	2300	430	95
MM0804007-2	Barra portafanali Inox fiorettato targa centrale	2400	430	95
MM0804007-3	Barra portafanali Inox fiorettato targa laterale	2300	245	105
MM0804007-4	Barra portafanali Inox fiorettato targa laterale	2400	245	105



OFFICINE MECCANICHE MAIOLI
Accessori per veicoli industriali



TAMPONI PARAURTI

Codice	Descrizione	L	S	H
MM0805001-1	Tampone tipo A	60	30	28
MM0805001-2	Tampone tipo B	200	57	60
MM0805001-3	Tampone tipo C	300	60	60
MM0805001-4	Tampone tipo D	300	80	100
MM0805001-5	Tampone tipo E	460	57	60
MM0805001-6	Tampone tipo F	460	57	70

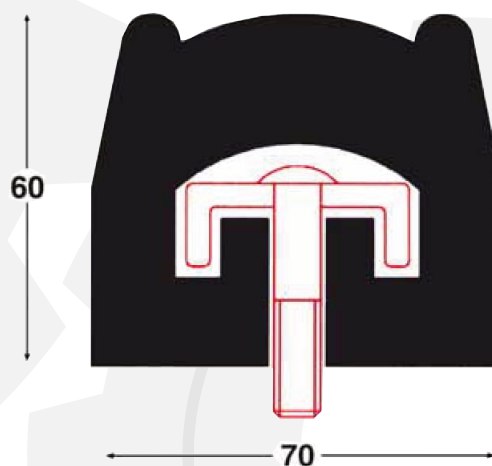
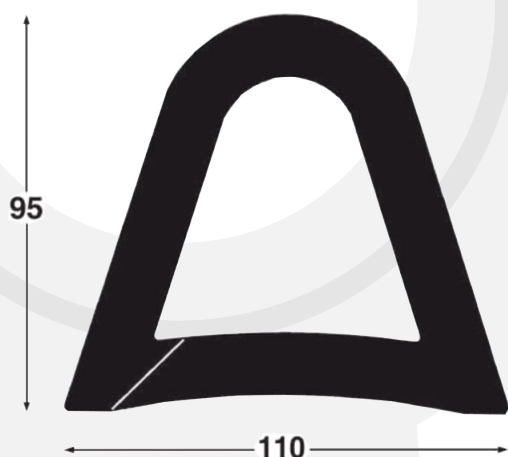
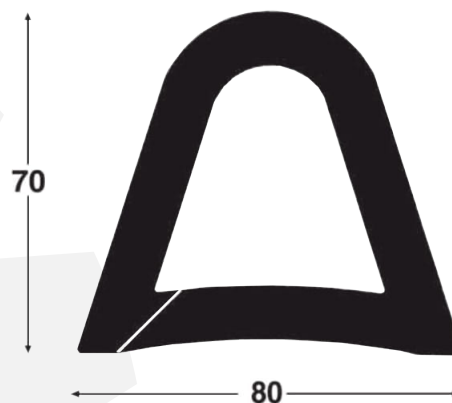
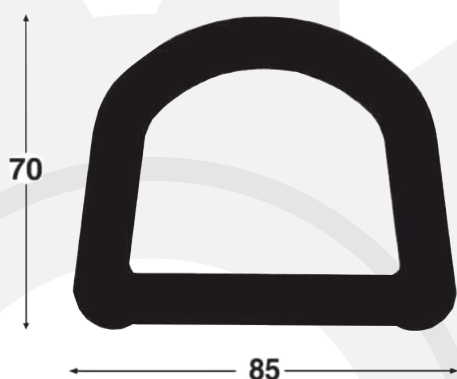

PROFILI PARACOLPI IN GOMMA

Codice	Descrizione	L
MM0805002-1	Profilo paracolpi in gomma nera 85X70	2600
MM0805002-2	Profilo paracolpi in gomma nera 80X70	2500
MM0805002-3	Profilo paracolpi in gomma nera 110X95	2500
MM0805002-4	Profilo paracolpi in gomma nera 70X60	2600



OFFICINE MECCANICHE MAIOLI
Accessori per veicoli industriali



TAMPONE PARAURTI A RULLO

Codice	Descrizione	L	H
MM0805003	Tampone paraurti a rullo lunghezza 190mm	110	120



OFFICINE MECCANICHE MAIOLI
Accessori per veicoli industriali

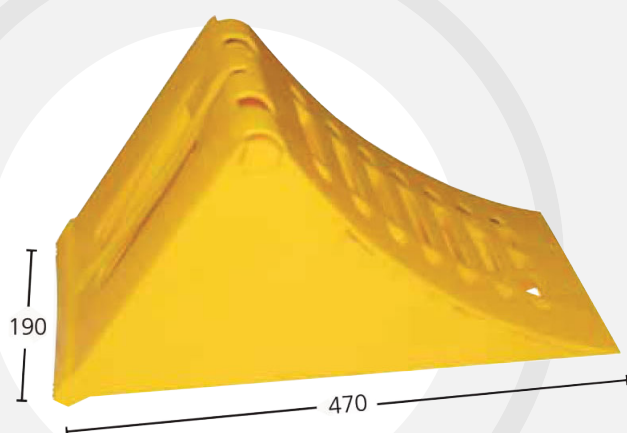

CALZATOIE OMOLOGATE

Codice	Descrizione
MM0806001-1	Supporto calzatoia grande (FOTO)
MM0806001-2	Calzatoia grande gialla in plastica (FOTO)
MM0806001-3	Calzatoia grande verniciata
MM0806001-4	Calzatoia grande zincata



OFFICINE MECCANICHE MAIOLI
Accessori per veicoli industriali

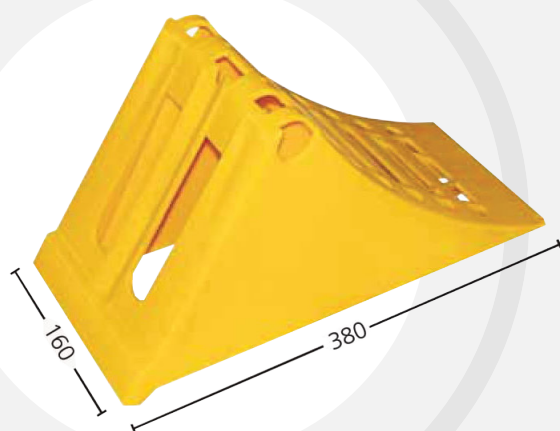

CALZATOIE OMOLOGATE

Codice	Descrizione
MM0806002-1	Supporto calzatoia media (FOTO)
MM0806002-2	Calzatoia media gialla in plastica (FOTO)
MM0806002-3	Calzatoia media verniciata
MM0806002-4	Calzatoia media zincata



OFFICINE MECCANICHE MAIOLI
Accessori per veicoli industriali



PARACICLISTA FISSO

Codice	Descrizione
MM0807001-1	Kit completo supporto paraciclista (FOTO)
MM0807001-2	Supporto protezione tubo D.60
MM0807001-3	Staffa per detto
MM0807001-4	Cavallotto per detto M.12
MM0807001-5	Montanti protezione alluminio
MM0807001-6	Fianco protezione alluminio assemblata



OFFICINE MECCANICHE MAIOLI
Accessori per veicoli industriali

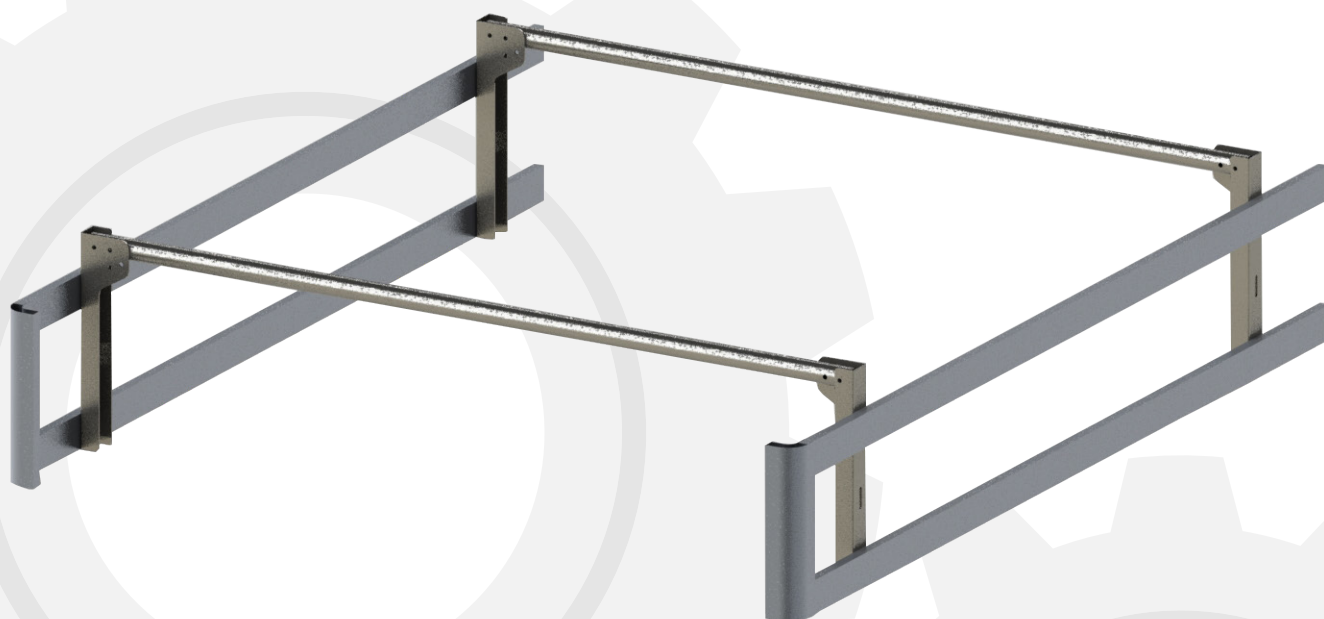

PARACICLISTA RIBALTABILE

Codice	Descrizione
MM0807002-1	Kit completo supporto paraciclista (FOTO)
MM0807002-2	Supporto protezione tubo D.60
MM0807002-3	Staffa per detto
MM0807002-4	Cavallotto per detto M.12
MM0807002-5	Montanti protezione alluminio
MM0807002-6	Fianco protezione alluminio assemblata



OFFICINE MECCANICHE MAIOLI

Accessori per veicoli industriali

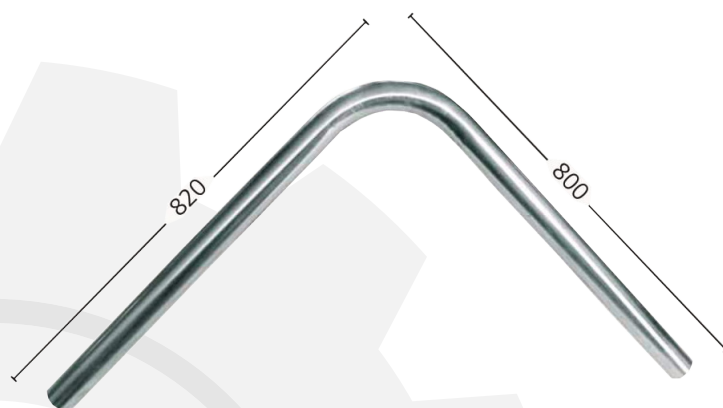

SUPPORTI PARACICLISTI

Codice	Descrizione
MM0808001	Supporto paraciclisti fisso zincato a 90° tubo diam. 50

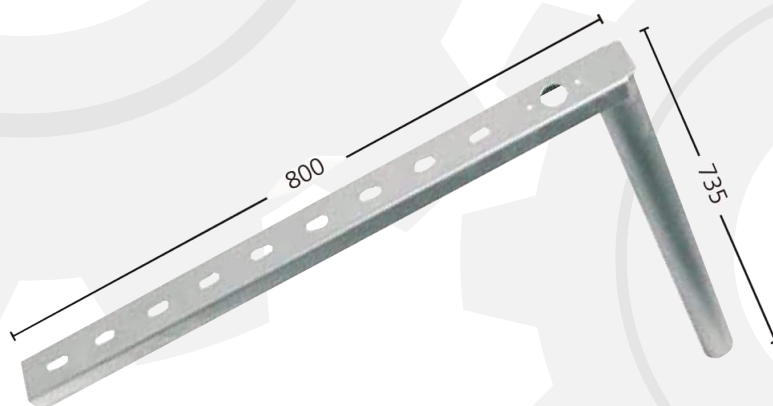

SUPPORTI PARACICLISTI

Codice	Descrizione
MM0808002	Supporto paraciclista asolato e zincato c/tubo H735X800mm



OFFICINE MECCANICHE MAIOLI

Accessori per veicoli industriali

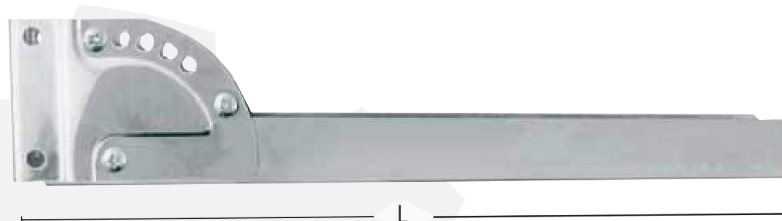

SUPPORTI PARACICLISTI

Codice	Descrizione	L
MM0808003-1	Supporto paraciclisti girevole assemblato piccolo zincato	575
MM0808003-2	Supporto paraciclisti girevole assemblato grande inox	735
MM0808003-3	Supporto paraciclisti girevole assemblato piccolo inox	575
MM0808003-4	Supporto paraciclisti girevole assemblato grande inox	735

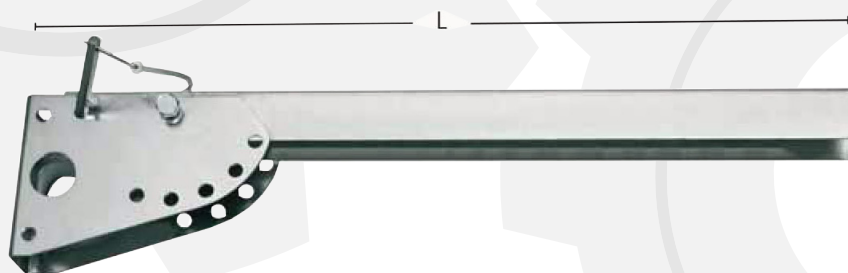

SUPPORTI PARACICLISTI

Codice	Descrizione	L
MM0808004	Supporto paraciclisti girevole smontato	700



OFFICINE MECCANICHE MAIOLI

Accessori per veicoli industriali



SUPPORTI PARACICLISTI

Codice	Descrizione
MM0808005	Supporto paraciclista a cannocchiale H700mm lung. registrabile



OFFICINE MECCANICHE MAIOLI
Accessori per veicoli industriali



PORTA TARGA

Codice	Descrizione
MM0809001	Porta targa estraibile inox

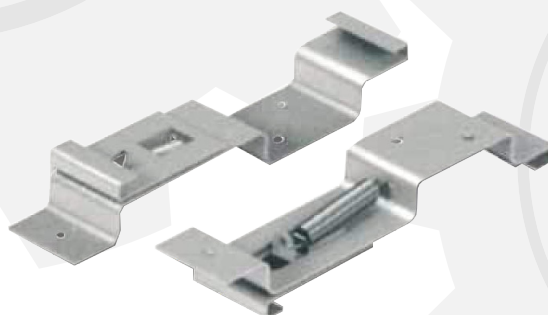

PORTA TARGA

Codice	Descrizione
MM0809002	Porta targa a molla inox



OFFICINE MECCANICHE MAIOLI

Accessori per veicoli industriali



VERRICELLI

Codice	Descrizione
MM0810001-1	Verricello diam. 48mm rinforzato con tubino Dx
MM0810001-2	Verricello diam. 48mm rinforzato con tubino Sx



VERRICELLI

Codice	Descrizione
MM0810002-1	Verricello diam. 48mm rinforzato con tubino e asola Dx
MM0810002-2	Verricello diam. 48mm rinforzato con tubino e asola Sx

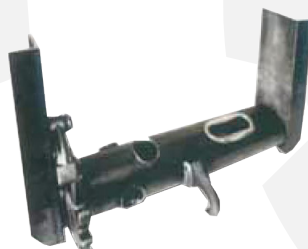

VERRICELLI

Codice	Descrizione
MM0810003-1	Verricello diam. 60mm rinforzato con tubino Dx
MM0810003-2	Verricello diam. 60mm rinforzato con tubino Sx
MM0810003-3	Verricello diam. 60mm rinforzato con tubino e asola Dx
MM0810003-4	Verricello diam. 60mm rinforzato con tubino e asola Sx



OFFICINE MECCANICHE MAIOLI

Accessori per veicoli industriali



VERRICELLI

Codice	Descrizione
MM0810004-1	Verricello diam. 48mm rinforzato con tubino Dx
MM0810004-2	Verricello diam. 48mm rinforzato con tubino Sx

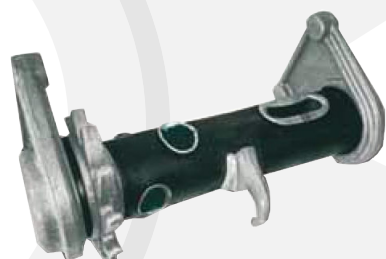

VERRICELLI

Codice	Descrizione
MM0810005-1	Verricello diam. 48mm rinforzato con tubino Dx
MM0810005-2	Verricello diam. 48mm rinforzato con tubino Sx



VERRICELLI

Codice	Descrizione
MM0810006-1	Verricello diam. 60mm rinforzato con tubino Dx
MM0810006-2	Verricello diam. 60mm rinforzato con tubino Sx
MM0810006-3	Verricello diam. 60mm rinforzato con tubino e asola Dx
MM0810006-4	Verricello diam. 60mm rinforzato con tubino e asola Sx



OFFICINE MECCANICHE MAIOLI
Accessori per veicoli industriali



BALCONCINO ANTERIORE SEMIRIMORCHIO

Codice	Descrizione	L	P	H
MM0811001	Balconcino anteriore semirimorchio	1800	350	2400



OFFICINE MECCANICHE MAIOLI
Accessori per veicoli industriali

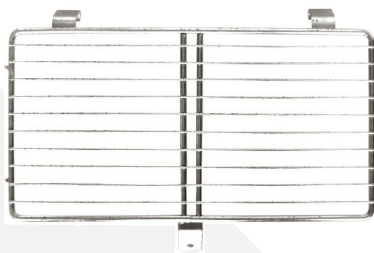

GRIGLIA PARASASSI NEW DAILY

Codice	Descrizione	L	H	SP.
MM0812001	Griglia parasassi new Daily	330	195	4/10

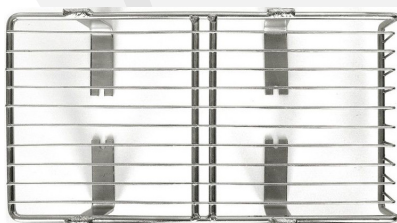

GRIGLIA PARASASSI DAILY 2000-2009

Codice	Descrizione	L	H	SP.
MM0812002	Griglia parasassi Daily 2000-2009	375	195	4/10



GRIGLIA PARASASSI FORD TRANSIT - 2017

Codice	Descrizione	L	H	SP.
MM0812003	Griglia parasassi Ford Transit <2017	420	130	4/10



OFFICINE MECCANICHE MAIOLI
Accessori per veicoli industriali

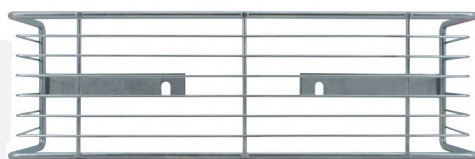

GRIGLIA PARASASSI FORD TRANSIT +2017

Codice	Descrizione	L	H	SP.
MM0812004	Griglia parasassi Ford Transit + 2017	420	130	4/10

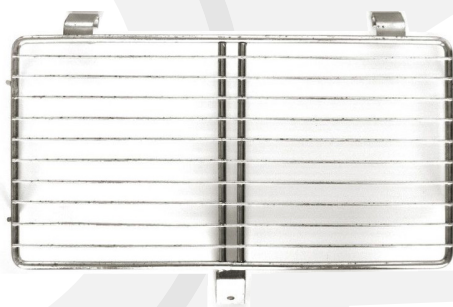

GRIGLIA PARASASSI NISSAN CABSTAR

Codice	Descrizione	L	H	SP.
MM0812005	Griglia parasassi Nissan Cabstar	370	195	4/10



GRIGLIA PARASASSI ATTACCO BARRA

Codice	Descrizione	L	H	SP.
MM0812006	Griglia parasassi attacco barra	490	195	4/10